

Front Fabrication

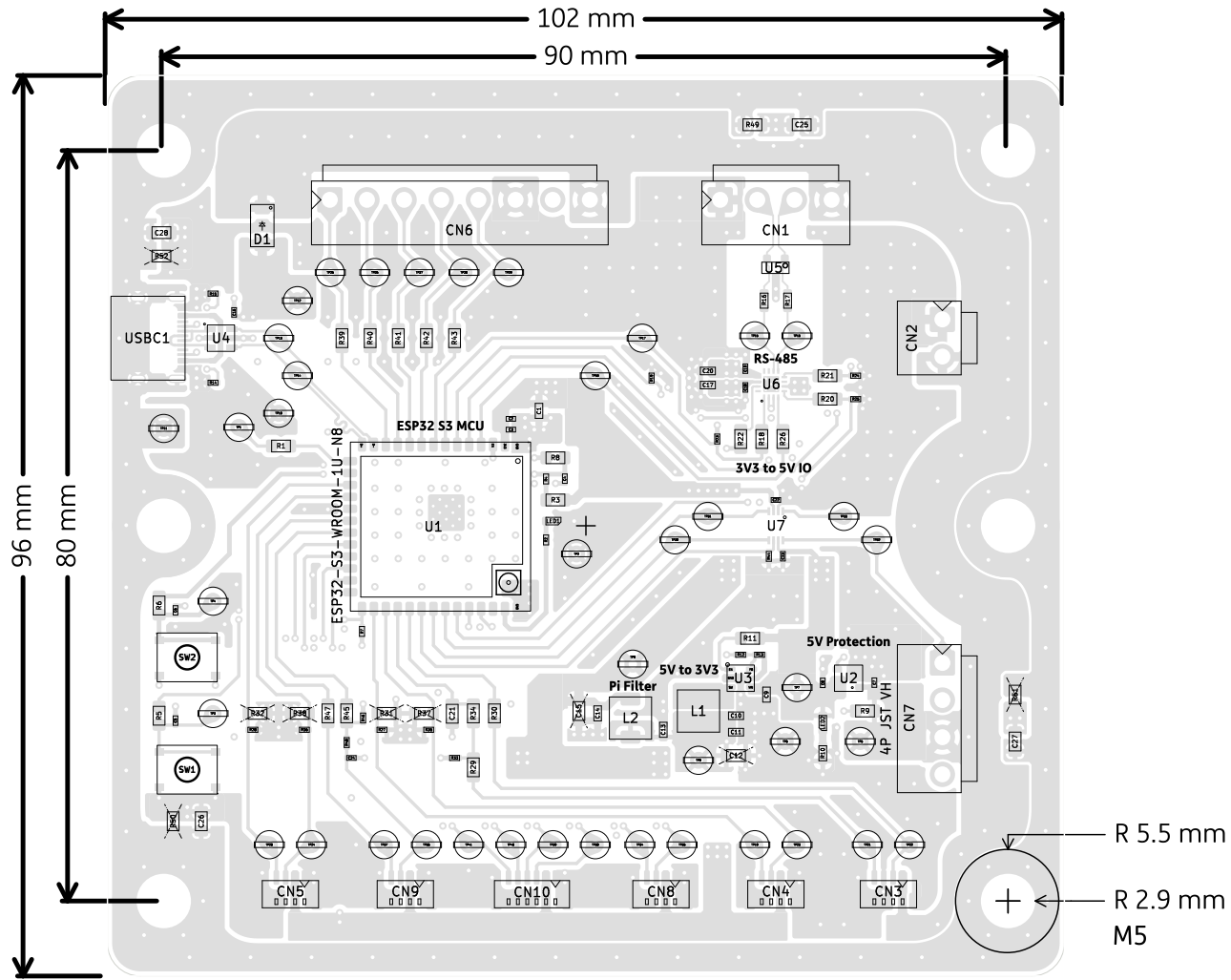

Board Name	Project Name	Company	Sheet Title & File Name	Date	Revision	Size
AstraControl	AstraBeam	LiveAstra Technologies	Front Fabrication AstraControl.kicad_pcb	2024-09-01	A	A4

Front Silkscreen

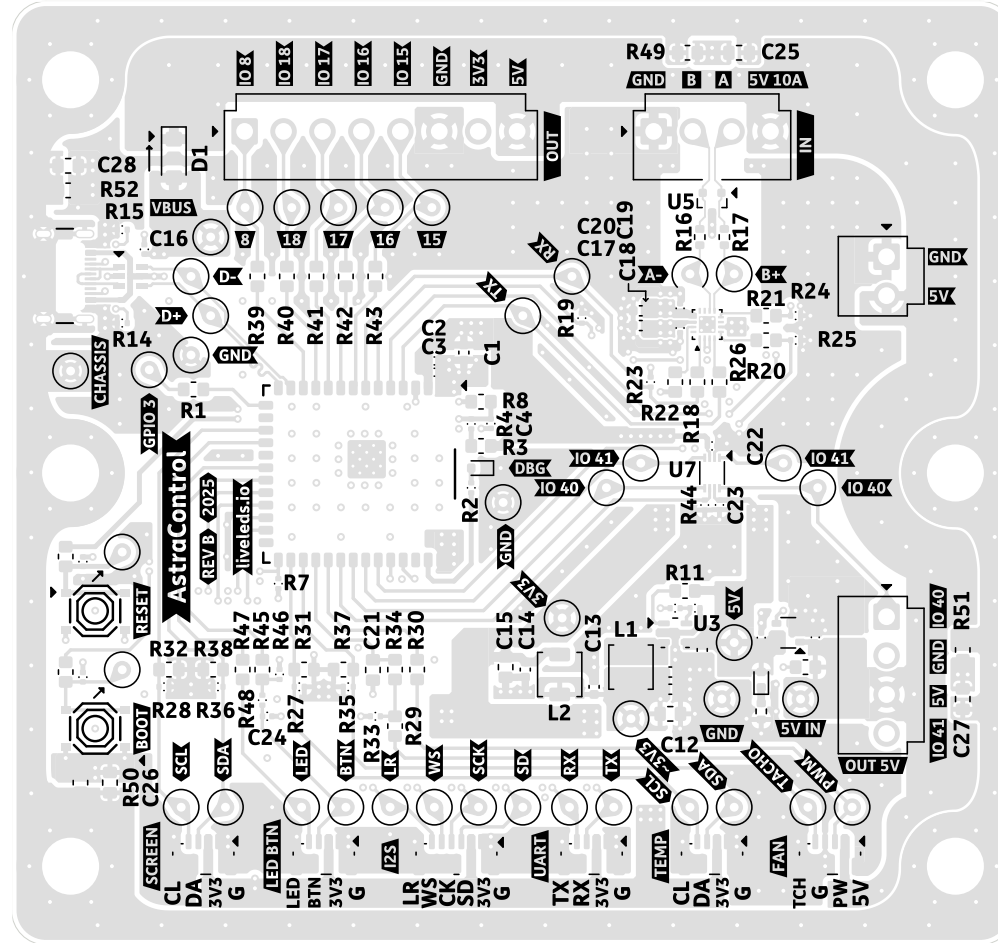

Board Name	Project Name	Company	Sheet Title & File Name	Date	Revision	Size
AstraControl	AstraBeam	LiveAstra Technologies	Front Silkscreen AstraControl.kicad_pcb	2024-09-01	A	A4

Back Fabrication

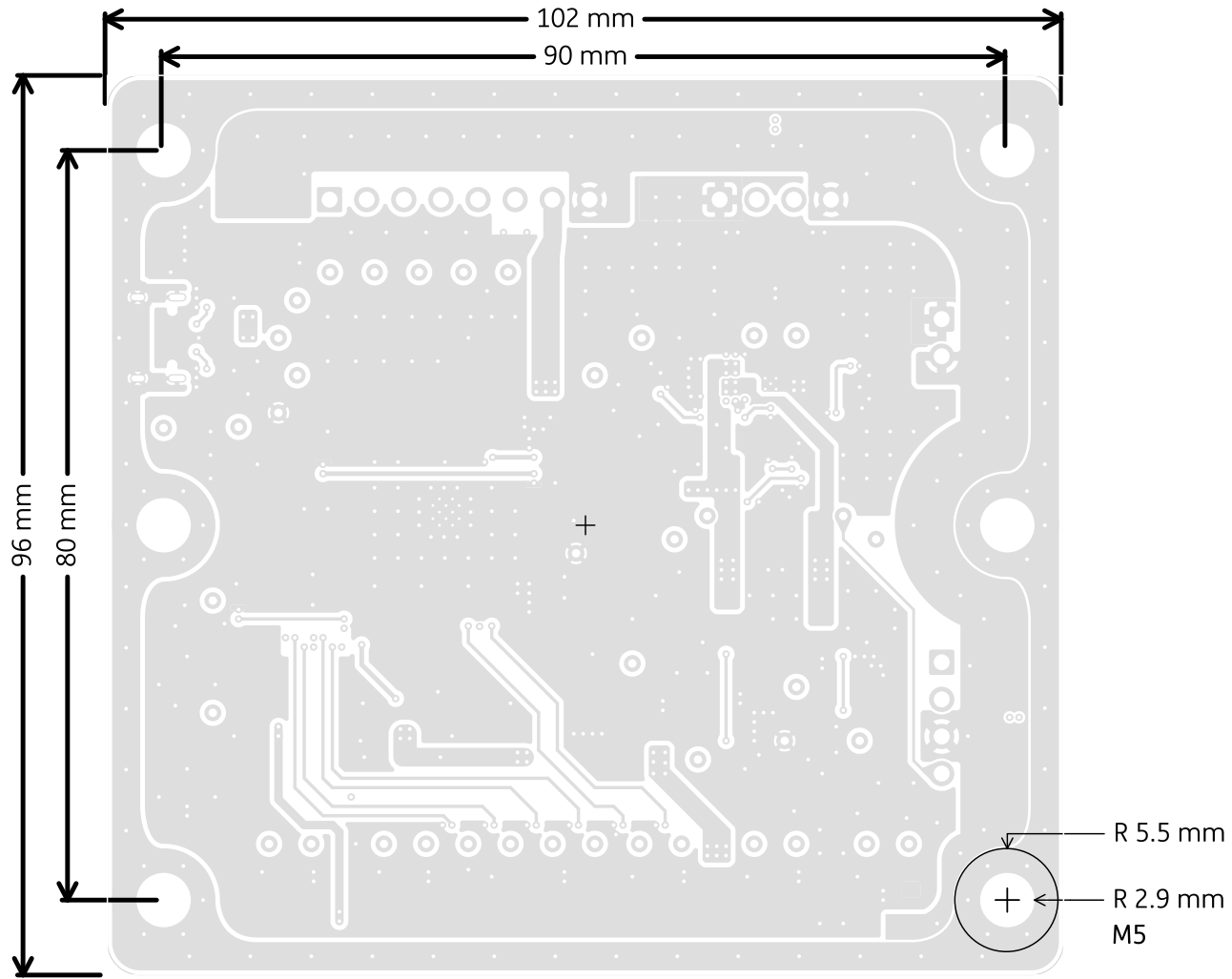

Board Name	Project Name	Company	Sheet Title & File Name	Date	Revision	Size
AstraControl	AstraBeam	LiveAstra Technologies	Back Fabrication AstraControl.kicad_pcb	2024-09-01	A	A4

Back Silkscreen

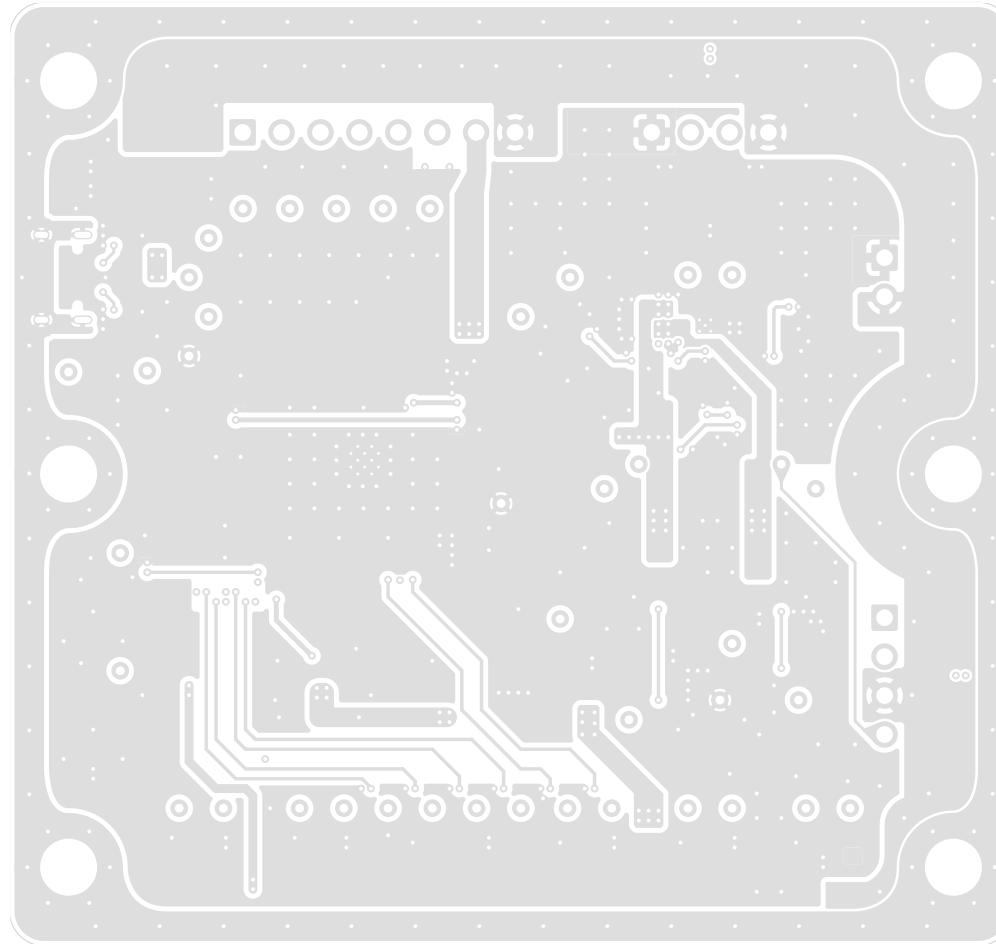

Board Name	Project Name	Company	Sheet Title & File Name	Date	Revision	Size
AstraControl	AstraBeam	LiveAstra Technologies	Back Silkscreen AstraControl.kicad_pcb	2024-09-01	A	A4

L1 SIG / PWR (FAB)

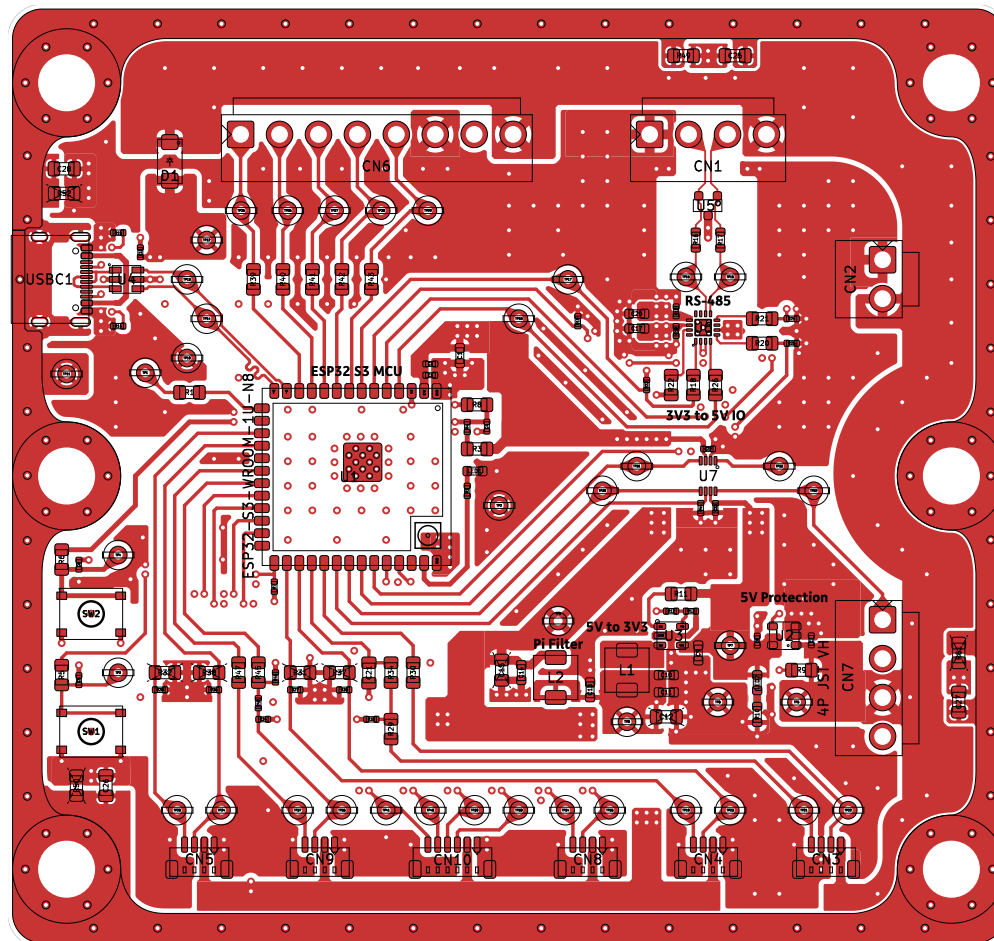

Board Name	Project Name	Company	Sheet Title & File Name	Date	Revision	Size
AstraControl	AstraBeam	LiveAstra Technologies	L1 SIG / PWR (FAB) AstraControl.kicad_pcb	2024-09-01	A	A4

L1 SIG / PWR

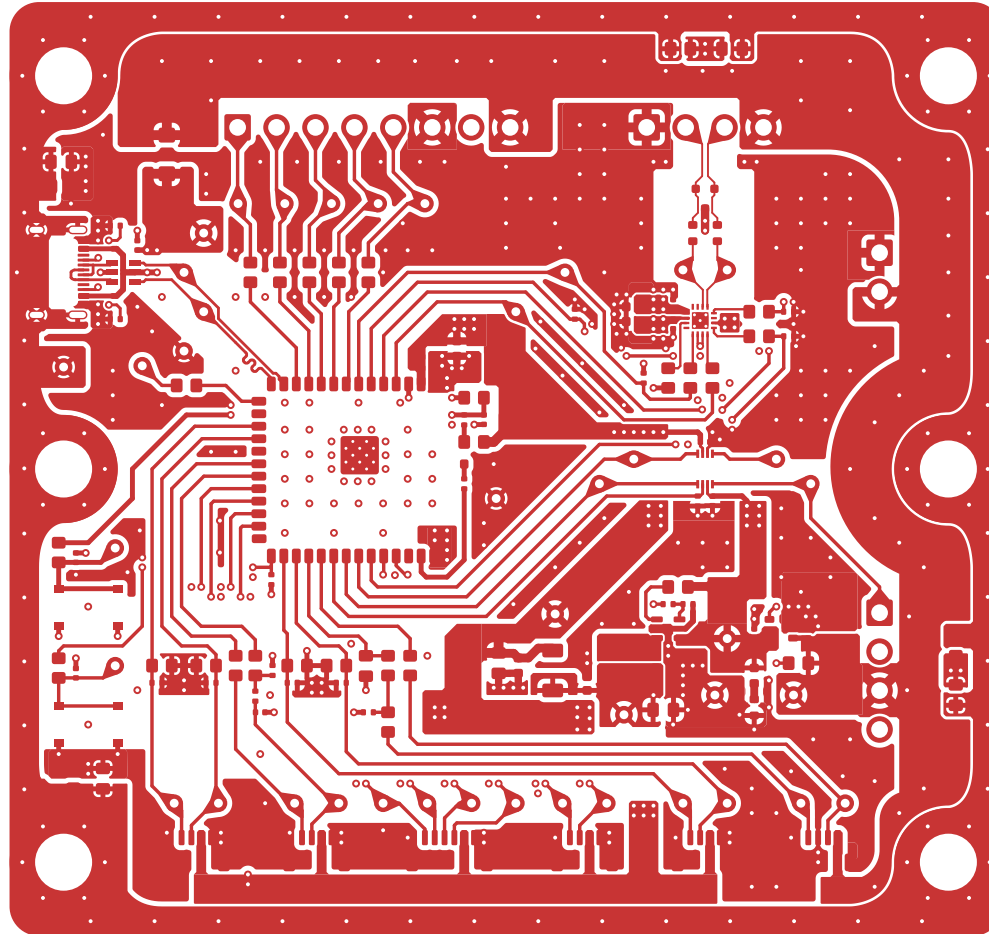

Board Name	Project Name	Company	Sheet Title & File Name	Date	Revision	Size
AstraControl	AstraBeam	LiveAstra Technologies	L1 SIG / PWR AstraControl.kicad_pcb	2024-09-01	A	A4

L2 GND (Front FAB)

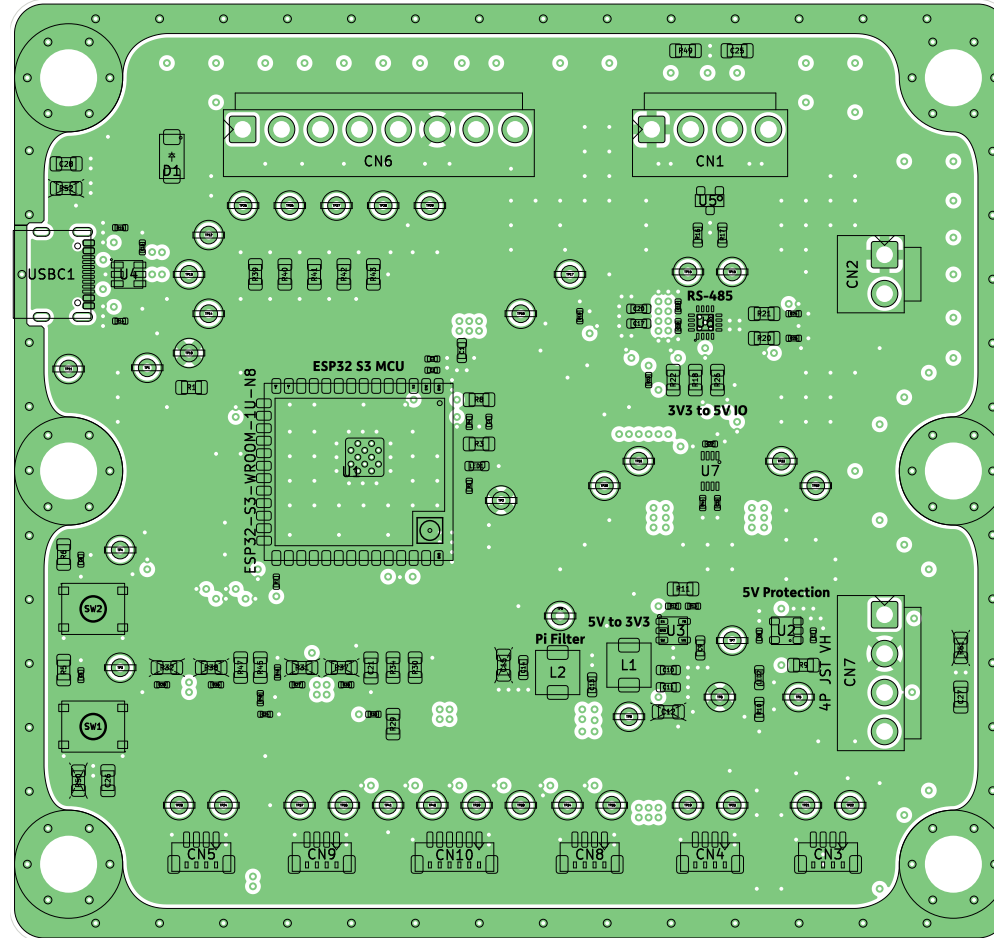

Board Name	Project Name	Company	Sheet Title & File Name	Date	Revision	Size
AstraControl	AstraBeam	LiveAstra Technologies	L2 GND (Front FAB) AstraControl.kicad_pcb	2024-09-01	A	A4

L2 GND

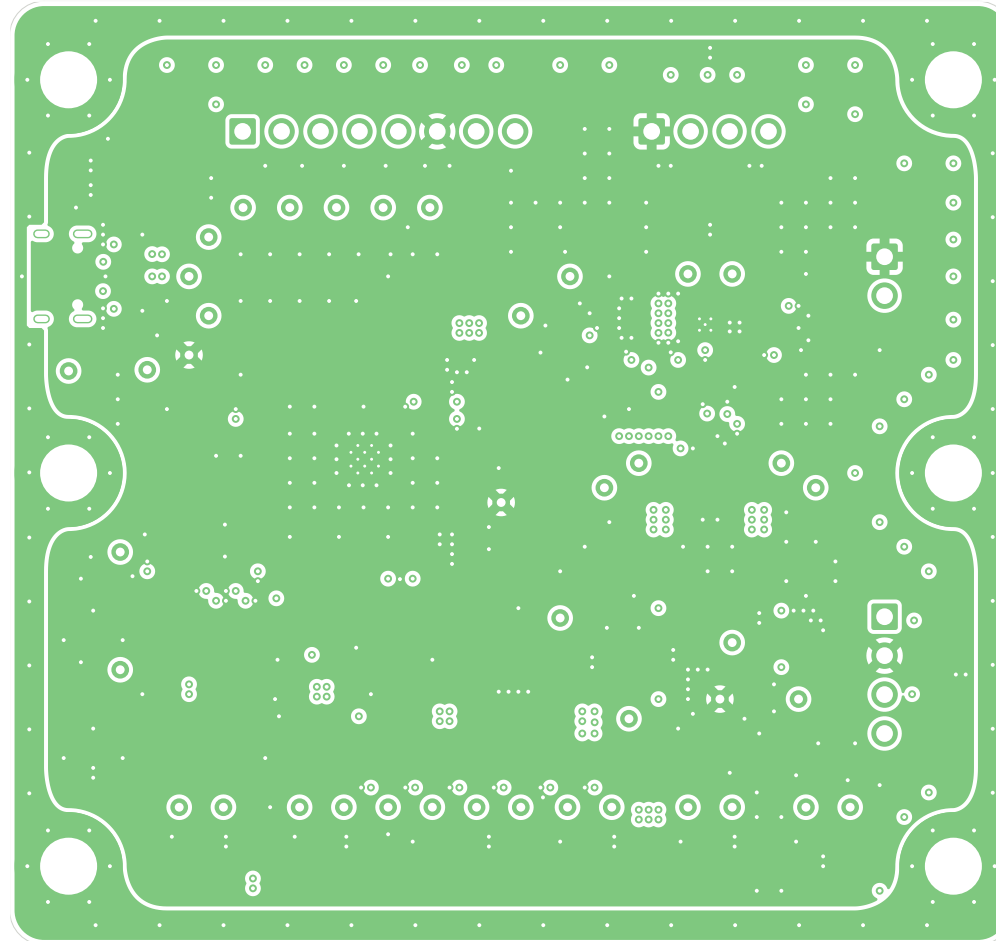

Board Name	Project Name	Company	Sheet Title & File Name	Date	Revision	Size
AstraControl	AstraBeam	LiveAstra Technologies	L2 GND AstraControl.kicad_pcb	2024-09-01	A	A4

L3 GND (Front FAB)

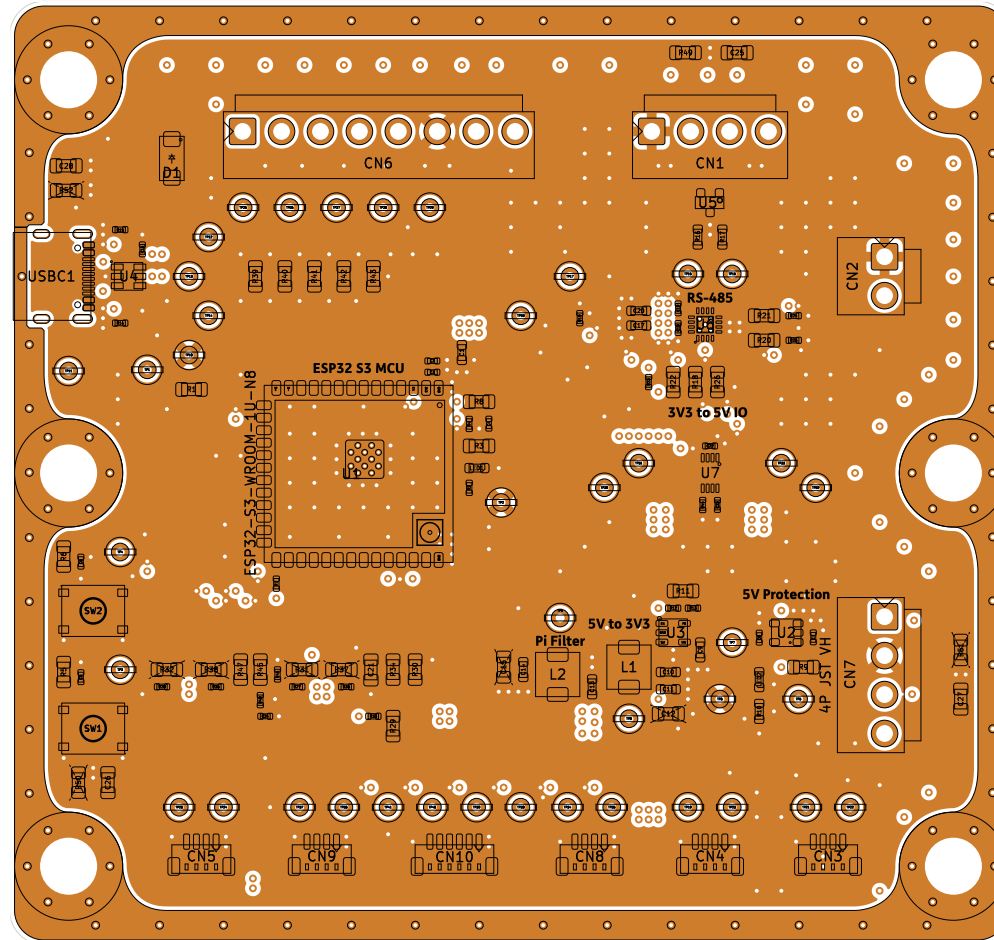

Board Name	Project Name	Company	Sheet Title & File Name	Date	Revision	Size
AstraControl	AstraBeam	LiveAstra Technologies	L3 GND (Front FAB) AstraControl.kicad_pcb	2024-09-01	A	A4

L3 GND

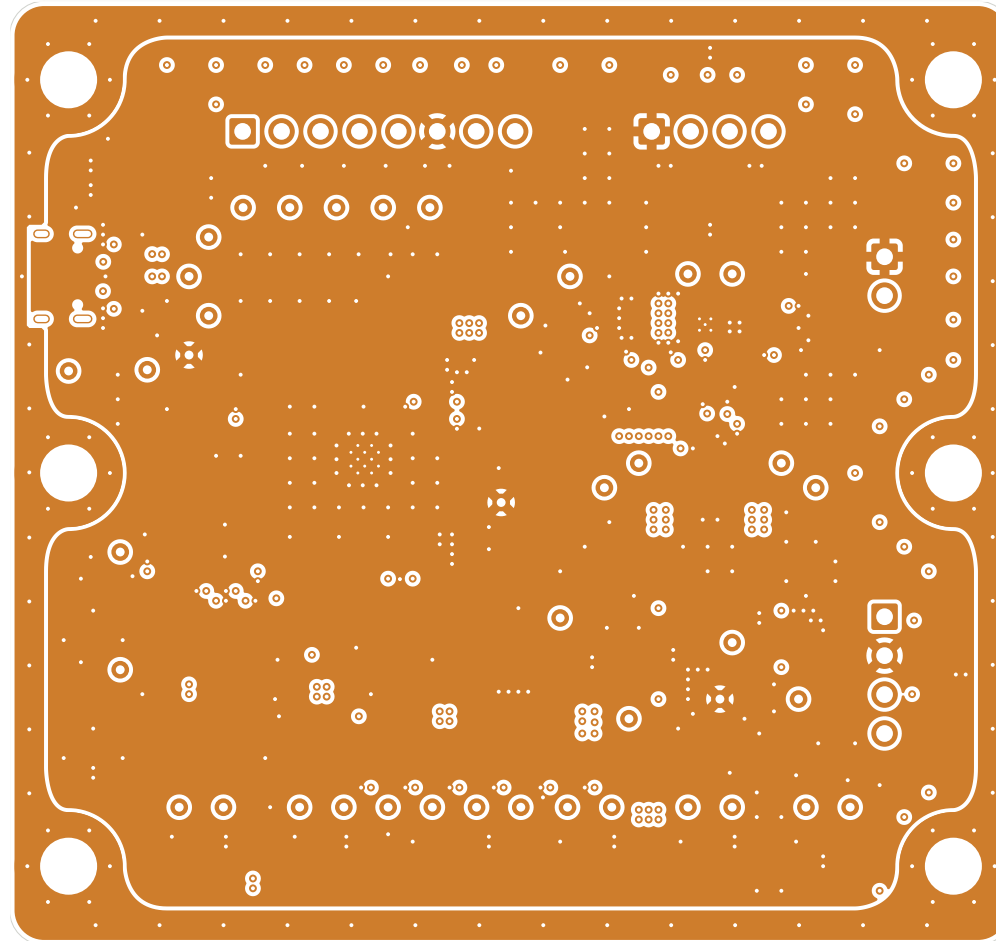

Board Name	Project Name	Company	Sheet Title & File Name	Date	Revision	Size
AstraControl	AstraBeam	LiveAstra Technologies	L3 GND AstraControl.kicad_pcb	2024-09-01	A	A4

L4 SIG / PWR (Front FAB)

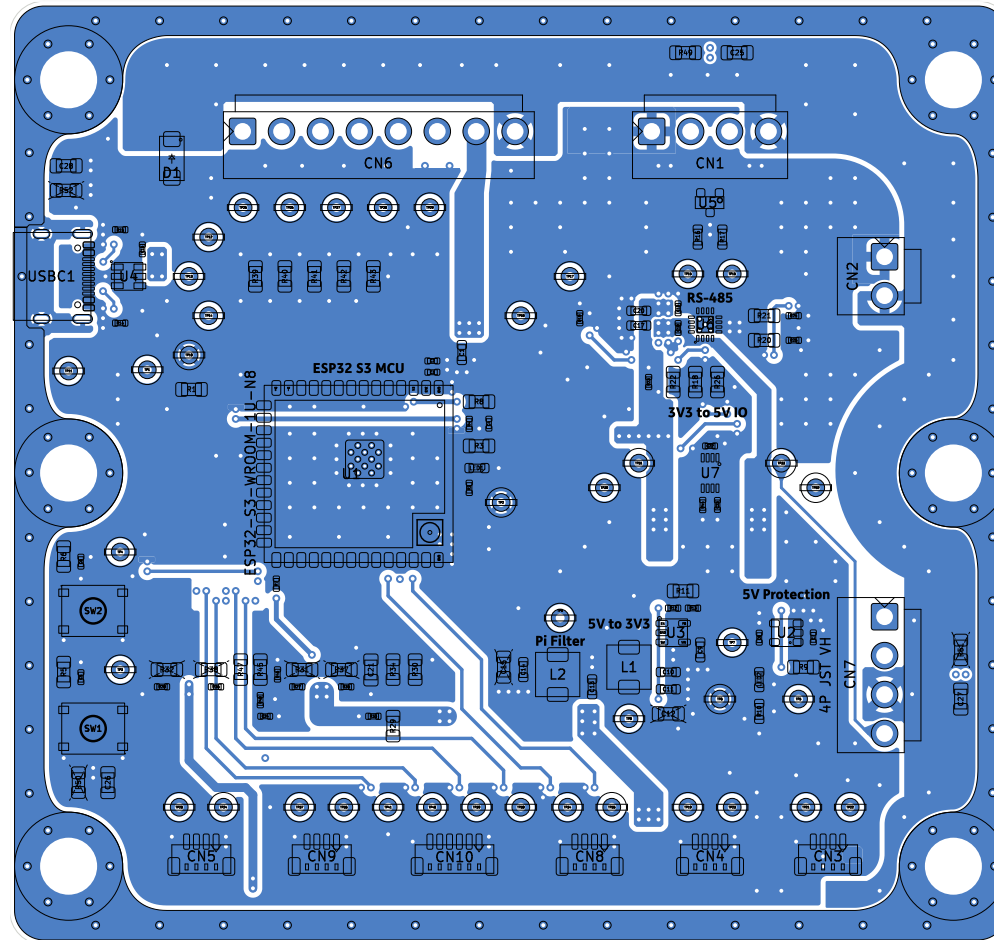

Board Name	Project Name	Company	Sheet Title & File Name	Date	Revision	Size
AstraControl	AstraBeam	LiveAstra Technologies	L4 SIG / PWR (Front FAB) AstraControl.kicad_pcb	2024-09-01	A	A4

L4 SIG / PWR

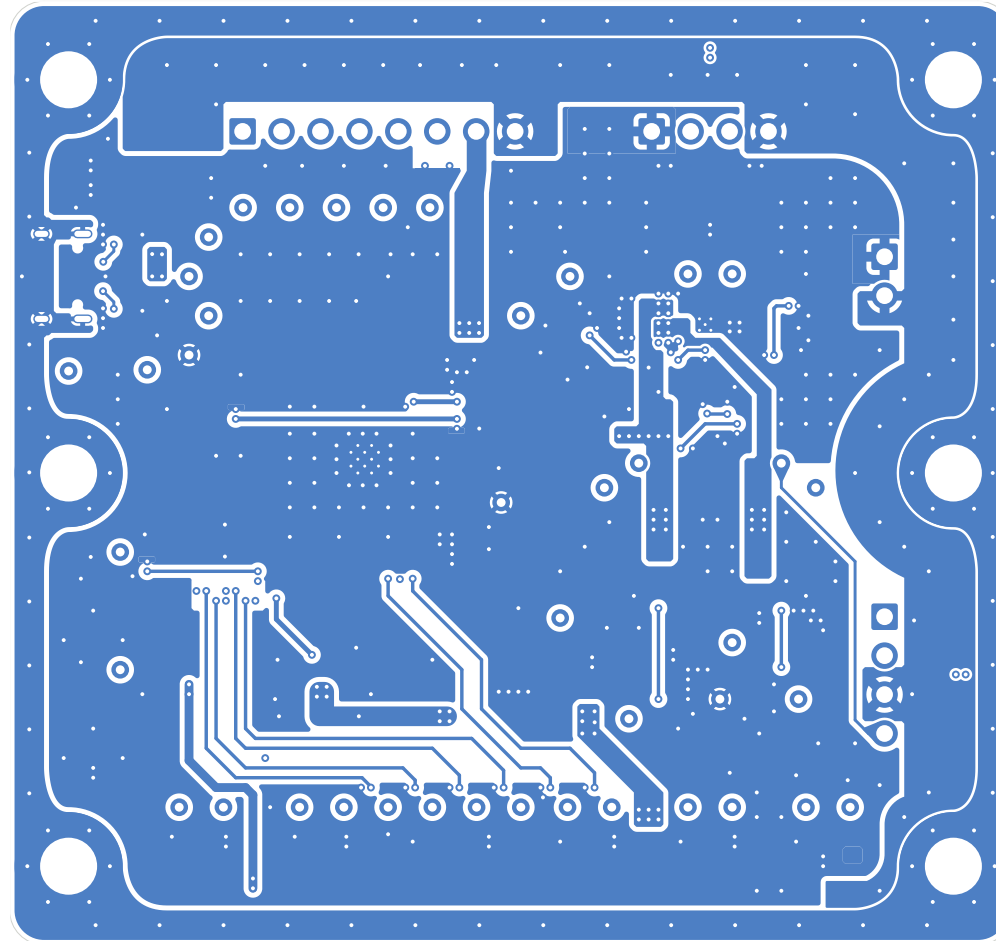

Board Name	Project Name	Company	Sheet Title & File Name	Date	Revision	Size
AstraControl	AstraBeam	LiveAstra Technologies	L4 SIG / PWR AstraControl.kicad_pcb	2024-09-01	A	A4

L1 (Component Dimensions)

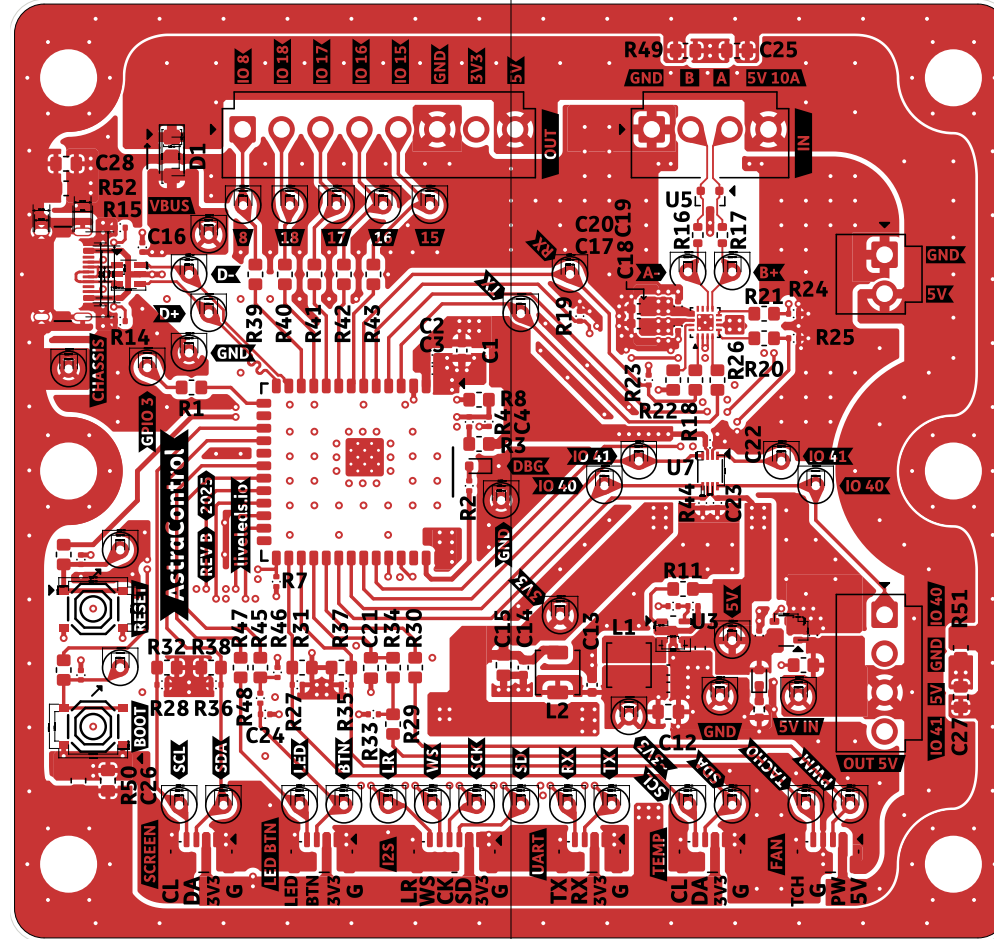

Board Name	Project Name	Company	Sheet Title & File Name	Date	Revision	Size
AstraControl	AstraBeam	LiveAstra Technologies	L1 (Component Dimensions) AstraControl.kicad_pcb	2024-09-01	A	A4